

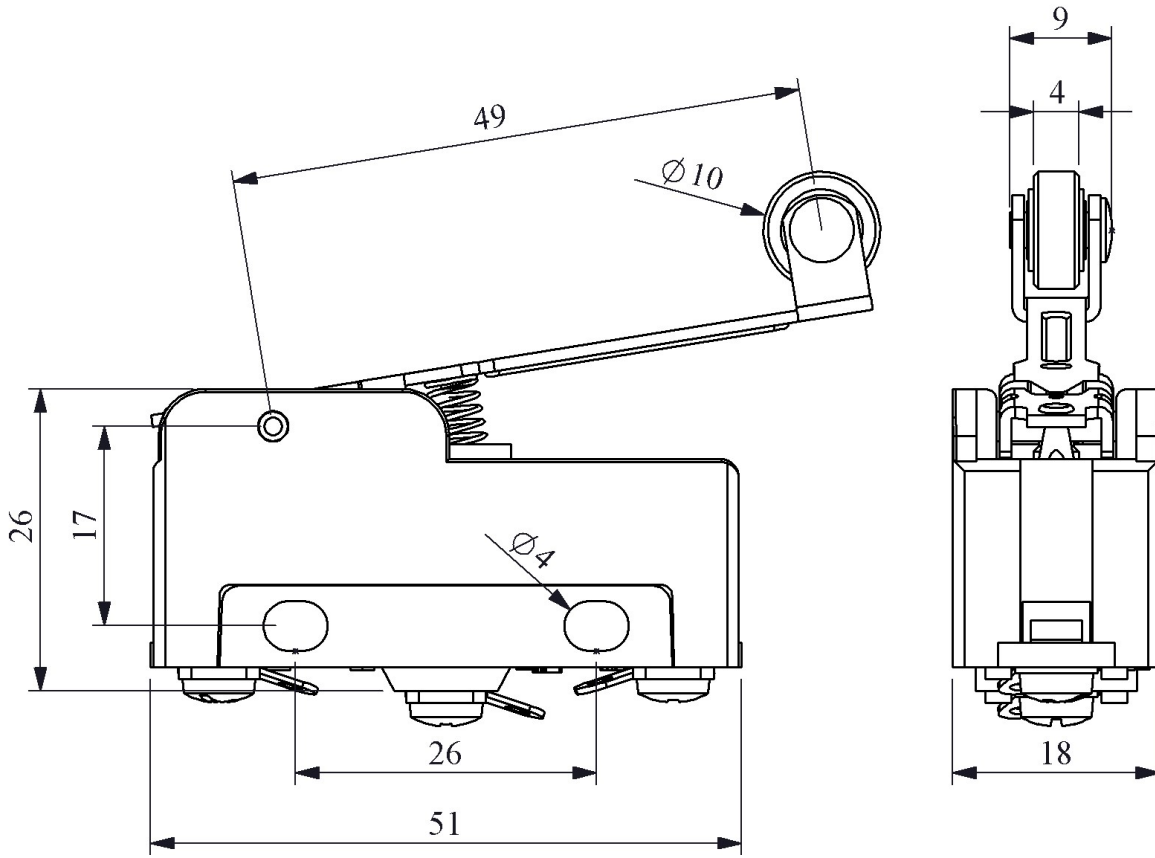

### MN2MIM2

Ürün	Plastik Mini Switch
Seri	MN2 Serisi
Uç Elemanı Malzemesi	Metal
Duyar Blok	Uzun Kollu Makaralı
Kontak	1CO
Kontak Akımı	<b>Ie</b> 6 A (250V AC)
Kullanım Kategorisi	AC15
Mekanik Ömür (Min Adet)	500000
Elektriksel Ömür (Min Adet)	100000
Çalışma Sıklığı (Açma Kapama/Saat)	Mek. 3000 Elk. 1200
Yalıtım Gerilimi (Ui)	660V
Darbe Dayanım Gerilimi (Uimp)	2.5 kV
Dielektrik Mukavemeti (Gövde-Kontak)	1.890V AC
Dielektrik Mukavemeti (Kontak-Kontak)	1.890V AC
İzolasyon Direnci	10 MΩ min. (500V DC)
Çalışma Sıcaklığı	-25 / +80 °C
Kirlenme Derecesi	3
Koruma Sınıfı	IP20 (IP40 Koruma Kapaklı)
Kontak Malzemesi	AgNi
Kablo Bağlantı Kesiti	1-2.5 mm <sup>2</sup>
Sıkma Kuvveti	1,5 Nm
Kısa devre kesme kapasitesi (Ics)	1 kA
Özellikler	V0 hammadde Farklı duyar blok seçenekleri
Standartlar / Belgeler	TS EN 60947-5-1





Devre Şeması

