

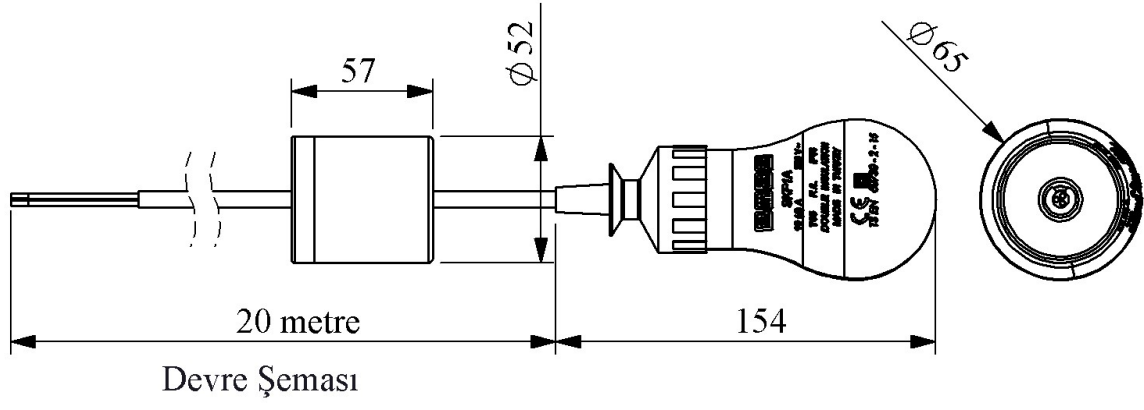

SKF1A-20

Product	Level Control Float Switch	
Type	Bulb	
Feature	With Standard Weight	
Cable	20m	
Phase Number	1 Phase	
Current	Ie	6 A (250V AC)
Usage Category	AC15	
Mechanical Life	Min Qty	30000
Electrical Life	Min Qty	10000
Operating Frequency	On-Off/Hour	Mek.120 Elk.120
Insulation Voltage	Ui	660V
Impulse Withstand Voltage	Uimp	2.75 kV
Dielectric Strength (Body-Contact)	2750V AC	
Dielectric Strength (Contact-Contact)	1890V AC	
Isolation Resistance	10 MΩ Min. (500 V DC)	
Operating Temperature	-15 / + 80 °C	
Protection Degree	IP68	
Contact Material	AgNi	
Cable Section	3*1 mm Kablo	
Serial	SKF1A Series	
Cable Type	PVC	
Specifications	Easy assembly	
	Feature to adjust the requested operation interval with weight	
	Different cable length options	
	Waterproof	
Standards / Certificates	TS EN 60730-2-15	





— Mavi

Siyah — Kahverengi