



### RE1P11AC048

<b>Product</b>	Power Relay
<b>Serial</b>	RE1 Series
<b>Contact</b>	3CO
<b>Pin</b>	11 Pin
<b>Contact Material</b>	AgNi 90/10
	9.10X2.5mm
<b>Connection Type</b>	Plug-in
<b>Operational Voltage</b>	48VAC
<b>Current (Ie)</b>	10A
<b>Voltage</b>	250V AC
<b>Usage Category</b>	AC-1
<b>Mechanical Life (Min Qty)</b>	10000000
<b>Electrical Life (Min Qty)</b>	100000
<b>Operating Frequency (On-Off/Hour)</b>	Mech. 18.000 Elec. 600
<b>Insulation Voltage (Ui)</b>	300 V
<b>Impulse Withstand Voltage (Uimp)</b>	1,5kV
<b>Dielectric Strength (Body-Contact)</b>	2.500 Vrms
<b>Dielectric Strength (Contact-Contact)</b>	1.500 Vrms
<b>Isolation Resistance</b>	MIN. 10 MΩ (500 V DC)
<b>Operating Temperature</b>	-15 / +80 °C
<b>Pollution Degree</b>	3
<b>Protection Degree</b>	IP40
<b>Specifications</b>	V0 PA 6.6 material
	DIN 35mm rail mountable with 8 and 11 pin socket
	Body design and connection ends for quick and error-free assembly
	Test button and indicator
	Large labelling area for code writing

Standards / Certificates TS EN 61810-1



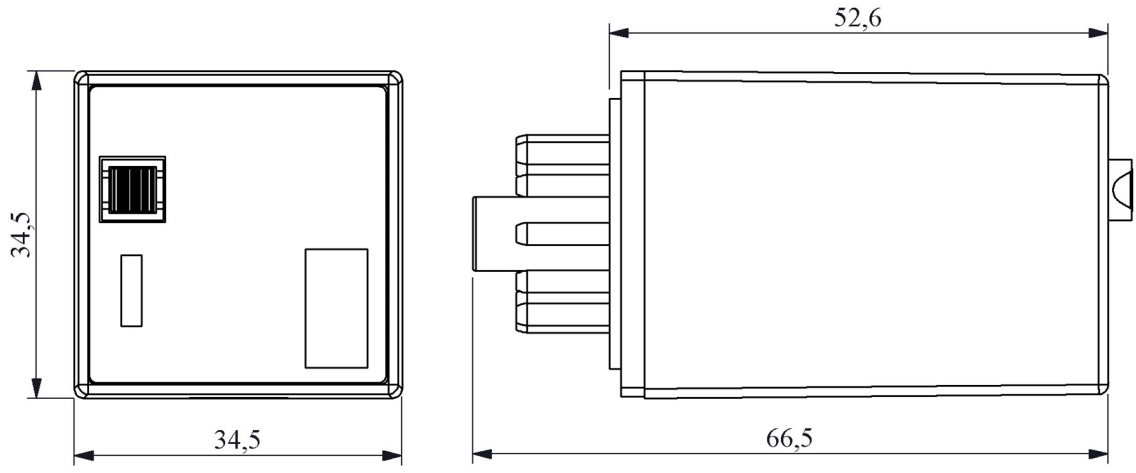

Devre Şeması

