



RE1P08DC024

Product	Power Relay
Serial	RE1 Series
Contact	2CO
Pin	8 Pin
Contact Material	AgNi 90/10
	9.10X2.5mm
Connection Type	Plug-in
Operational Voltage	24VDC
Current (Ie)	10A
Voltage	250V AC
Usage Category	AC-1
Mechanical Life (Min Qty)	10000000
Electrical Life (Min Qty)	100000
Operating Frequency (On-Off/Hour)	Mech. 18.000 Elec. 600
Insulation Voltage (Ui)	300 V
Impulse Withstand Voltage (Uimp)	1,5kV
Dielectric Strength (Body-Contact)	2.500 Vrms
Dielectric Strength (Contact-Contact)	1.500 Vrms
Isolation Resistance	MIN. 10 MΩ (500 V DC)
Operating Temperature	-15 / +80 °C
Pollution Degree	3
Protection Degree	IP40
Specifications	V0 PA 6.6 material
	DIN 35mm rail mountable with 8 and 11 pin socket
	Body design and connection ends for quick and error-free assembly
	Test button and indicator
	Large labelling area for code writing

Standards / Certificates TS EN 61810-1



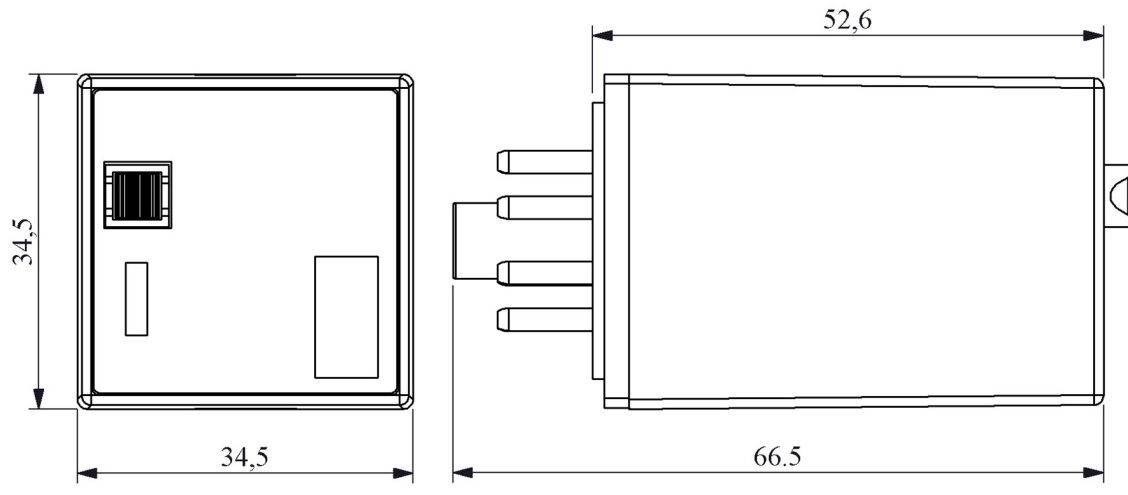

Devre Şeması

