



### L52K23LUM321

<b>Product</b>	Limit Switch
<b>Serial</b>	L52 Metal Body
<b>Actuator Material</b>	Metal
<b>Actuator</b>	With Right Angle Key Safety Switch
<b>Contact Action</b>	Slow Action
<b>Contact</b>	1NO+1NC
<b>Current (Ie)</b>	3 A (240V AC)
<b>Usage Category</b>	AC15
<b>Mechanical Life (Min Qty)</b>	10000000
<b>Electrical Life (Min Qty)</b>	1000000
<b>Operating Frequency (On-Off/Hour)</b>	Mech. 3000 Elec. 1800
<b>Insulation Voltage (Ui)</b>	300 V
<b>Impulse Withstand Voltage (Uimp)</b>	2.5 kV
<b>Dielectric Strength (Body-Contact)</b>	1.890V AC
<b>Dielectric Strength (Contact-Contact)</b>	1.890V AC
<b>Isolation Resistance</b>	10 MΩ (500 V DC)
<b>Operating Temperature</b>	-25 / + 80 °C
<b>Pollution Degree</b>	3
<b>Protection Degree</b>	IP65
<b>Contact Material</b>	AgNi
<b>Cable Section</b>	1-2.5 mm <sup>2</sup>
<b>Screw Torque</b>	1.5Nm
	1 kA
<b>Specifications</b>	Metal Body and Cover
	1 cable entry suitable for PG13.5 or M20x1.5 optional gland
	Changeable contact block
	Different actuator options

Standards / Certificates TS EN 60947-5-1 UL 508 VDE 0660



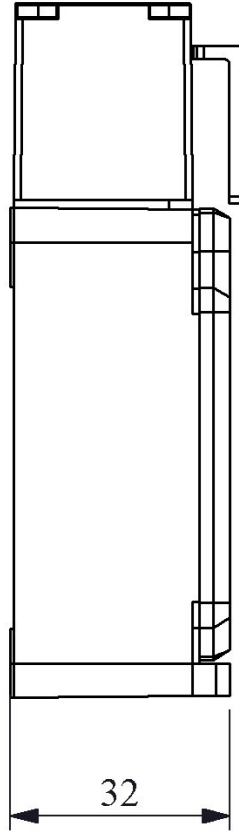
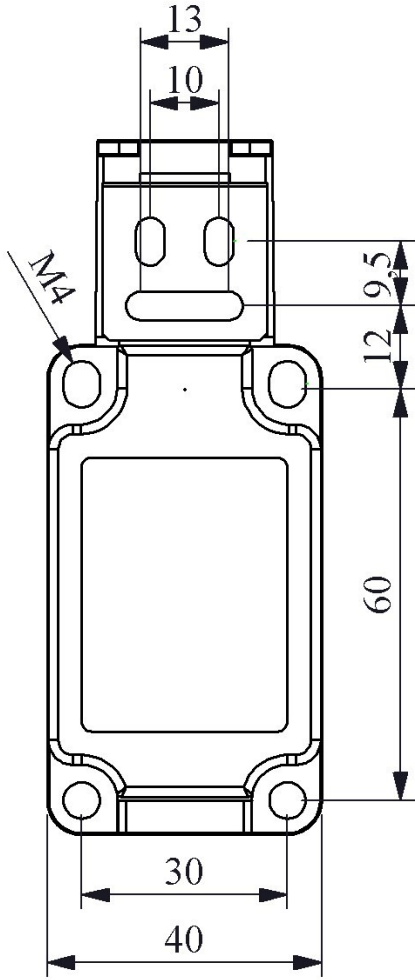

Devre Şeması

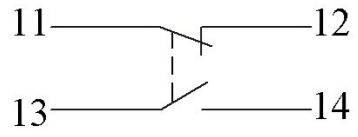

Yavaş Hareketli

OPEN/CLOSE



Akış Diyagramı