

HJ21A25UN

Operational Frequency		50 - 60Hz
Product		Contacteur with Thermic in Box
Current	Ie	25A
Thermic Current		7,30-10,20A
Calibration Interval		
Usage Category		AC 3
Mechanical Life	Min Qty	100000
Electrical Life	Min Qty	100000
Operating Frequency	On-Off/Hour	Mech. 600 Elec. 600
Insulation Voltage	Ui	690V AC
Impulse Withstand Voltage	Uimp	6 kV
Dielectric Strength (Body-Contact)		1890V AC
Dielectric Strength (Contact-Contact)		1890V AC
Isolation Resistance		10 MΩ (500 V DC)
Operating Temperature		-5 / +40 °C
Pollution Degree		3
Protection Degree		IP30
Cable Section		2,5 mm ²
Screw Torque		1,8 Nm
Short Circuit Breaking Capacity	Ics	50 kA
Serial		HJ Series
Voltage		220-230V/50-60HZ
Enclosure		with Rocker+Reset Button+Pilot
Specifications		High switching capacity
		From 9A to 55A with 3 different sizes
		Temperature compensated

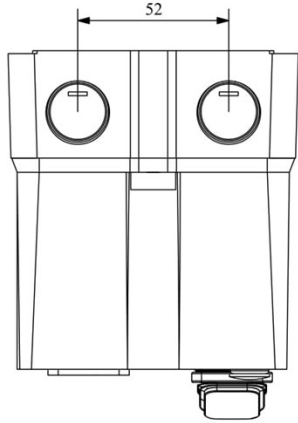
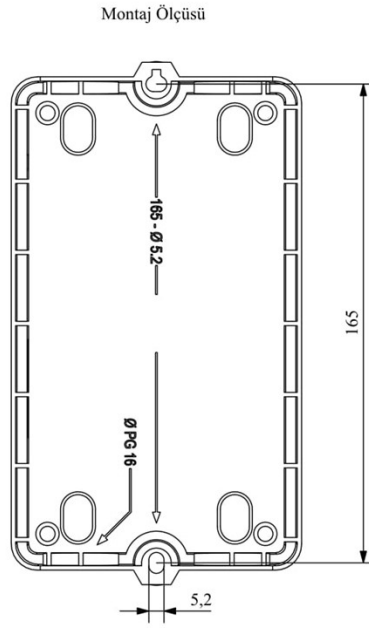
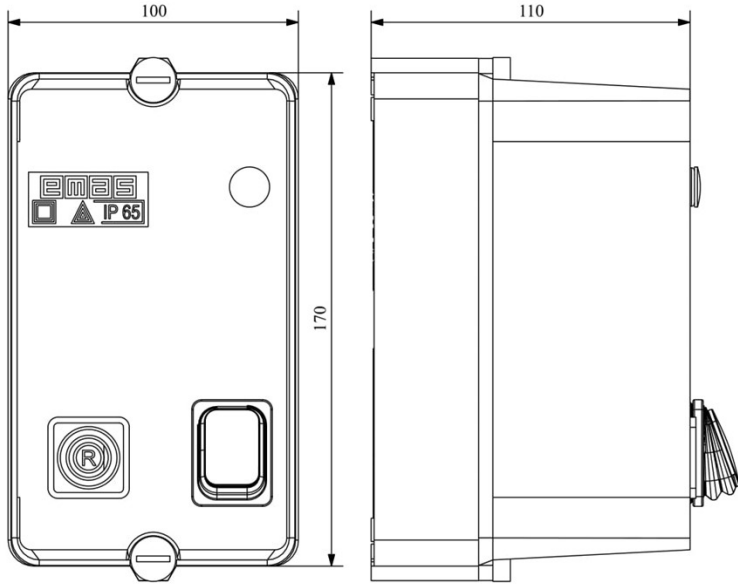

TRIFAZE ELEKTRİK ŞEMASI

220 V Bobinli Cihazlar İçin Geçerlidir.

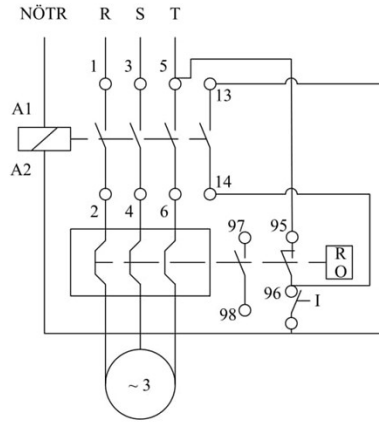

380 V Bobinli Cihazlar için Geçerlidir.

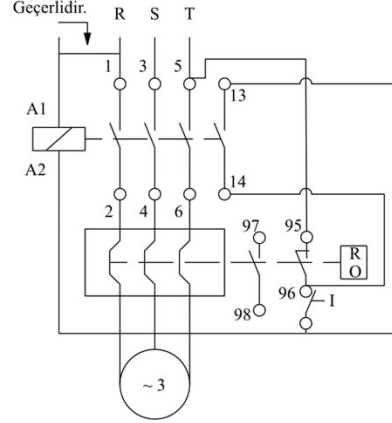

MONOFAZE ELEKTRİK ŞEMASI

