





**B172DM**

Operating Current		5-20 mA (12-30V AC/DC)
Operational Frequency		50 Hz
Operational Voltage		12-30V AC/DC
Product		Control Unit
Model		Spring
Type		Flush
Contact		1NO+1NC
Color		Blue
Illumination		with LED
Dia		22 mm
Current	Ie	4 A (250V AC)
Usage Category		AC 15
Power Consumption		0.7 W
Mechanical Life	Min Qty	500000
Electrical Life	Min Qty	100000
Operating Frequency	On-Off/Hour	Mech. 1200 Elec. 1200
Insulation Voltage	Ui	300V
Impulse Withstand Voltage	Uimp	2.5 kV
Dielectric Strength (Body-Contact)		2.500V AC
Dielectric Strength (Contact-Contact)		1.500V AC
Isolation Resistance		10 MΩ min. (500V DC)
Operating Temperature		-15 / + 70 °C
Pollution Degree		3
Protection Degree		IP50
Contact Material		AgNi
Cable Section		1.5-2.5 mm ²
Screw Torque		1,5 Nm
Short Circuit Breaking Capacity	Ics	1 kA

Production Time	31.12.1899 00:00:00
Serial	B Series Plastic
Specifications	Non-flammable V0 PA6.6 contact blocks
	Various illumination contact blocks availability
	Variety of products for all areas of application
Standards / Certificates	IEC 60947-5-1 TS EN 60947-5-1 UL 508 VDE 0660
   	

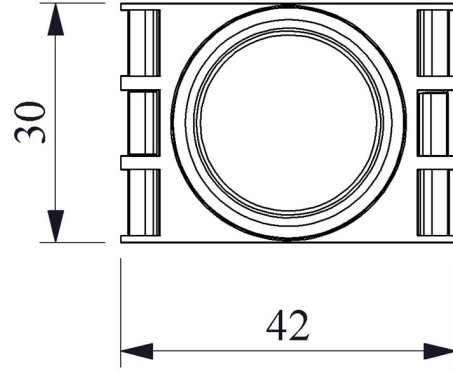
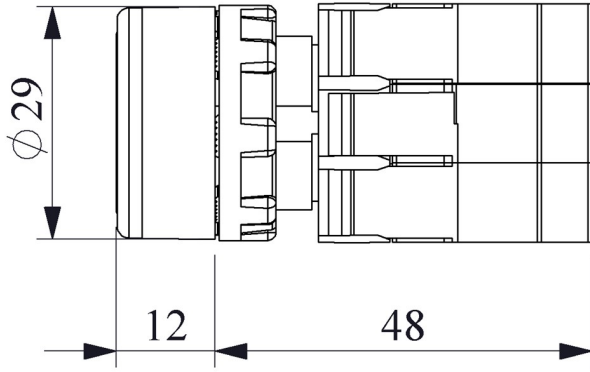

Devre Şeması

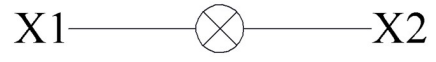
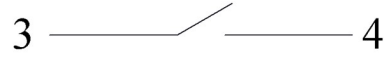

Montaj Ölçüsü $\phi 22.4 \pm 0.2$ mm