



A54B1K11

| | |
|--|----------------------------------|
| Product | Rocker Switch |
| Serial | A54 Series |
| Connection / Nominal Dimension | 30*22mm |
| Body Color | Black Body |
| Contact | 2NO |
| Illumination | with Illumination |
| Connection Type | with Terminal |
| Print | (0-I) Marked |
| Color | Red |
| Current | Ie 16 A (250V AC) |
| Usage Category | AC15 |
| Mechanical Life (Min Qty) | 50000 |
| Electrical Life (Min Qty) | 50000 |
| Operating Frequency (On-Off/Hour) | Mech.900 Elec.900 |
| Insulation Voltage (Ui) | 300 V |
| Impulse Withstand Voltage (Uimp) | 2.5 kV |
| Dielectric Strength (Body-Contact) | 2.500V AC |
| Dielectric Strength (Contact-Contact) | 1.500V AC |
| Isolation Resistance | 10 MΩ min. (500V DC) |
| Operating Temperature | -15 / +80 °C |
| Pollution Degree | 3 |
| Protection Degree | IP65 |
| Contact Material | AgNi |
| Cable Section | Terminal 6,3*0,8 mm |
| | 1 kA |
| Specifications | With or w/o illumination options |

Black or white body and 4 colour button options

Standards / Certificates TS EN 61058-1

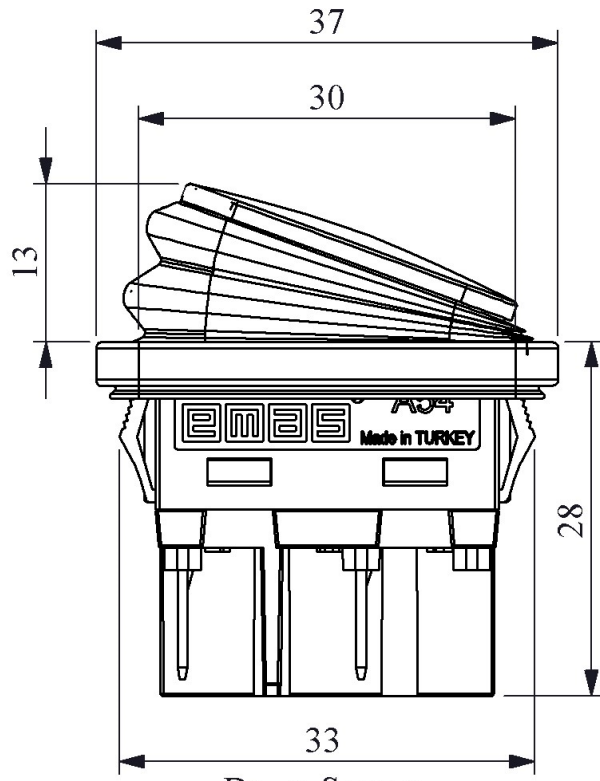



Devre Şeması

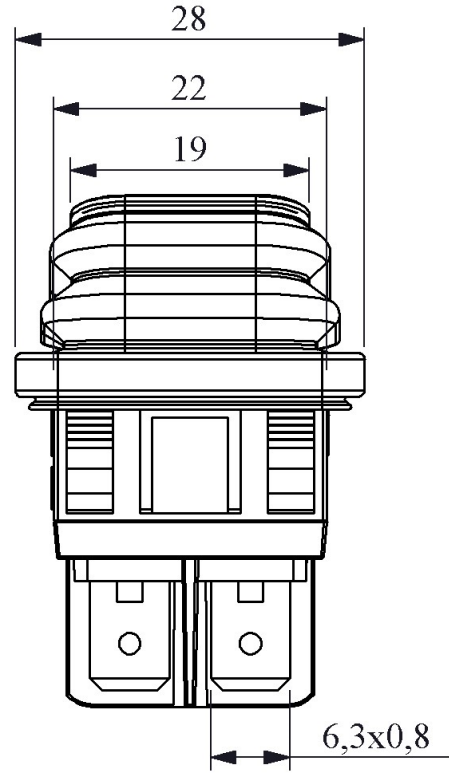
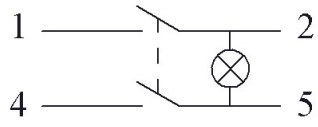

Montaj Ölçüsü 30,2x22,2mm